

Plug and Sockets

BCZ85 Series Explosion-proof Plug and Sockets

- ◆ Explosion protection to
 - CENELEC
 - IEC
 - NEC
- ◆ Can be used in
 - Zone 1 and Zone 2
 - Zone 21 and Zone 22
- ◆ Four enclosure types; Four current ratings (16A, 32A, 63A, 125A); 3P, 4P or 5P.
- ◆ Plug can only be pulled out when switch is off; turn on the power after inserting the plug.
- ◆ Copper-free aluminium enclosure; powder coated external surface.

■ Catalogue number logic

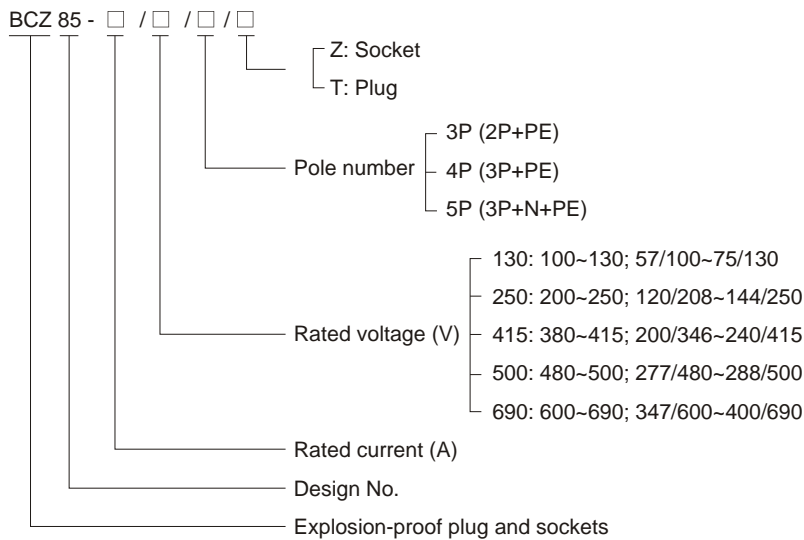







































Zones 1&2; 21&22

Plug and Sockets

BCZ85 Series Explosion-proof Plug and Sockets

3

Selection table

Type	Current (A)	Voltage (V)	Pole number	Schematic diagram	h	Colour	Ordering code	Weight (kg)
	16	100~130	2P+PE		4	Yellow	30147	2.60
		200~250			6	Blue	30148	2.60
		100~130	3P+PE		4	Yellow	30149	2.60
		200~250			9	Blue	30150	2.60
		380~415			6	Red	30151	2.60
		480~500			7	Black	30152	2.60
		600~690			5	Black	30153	2.60
		57/100~75/130			4	Yellow	30154	2.60
		120/208~144/250	3P+N+PE		9	Blue	30155	2.60
		200/346~240/415			6	Red	30156	2.60
		277/480~288/500			7	Black	30157	2.60
		347/600~400/690			5	Black	30158	2.60
	32	200~250	2P+PE		6	Blue	30159	3.40
		200~250	3P+PE		9	Blue	30160	3.40
		380~415			6	Red	30161	3.40
		480~500			7	Black	30162	3.40
		600~690			5	Black	30163	3.40
		120/208~144/250	3P+N+PE		9	Blue	30164	3.40
		200/346~240/415			6	Red	30165	3.40
		277/480~288/500			7	Black	30166	3.40
		347/600~400/690			5	Black	30167	3.40
	63	200~250	3P+PE		9	Blue	30168	4.50
		380~415			6	Red	30169	4.50
		480~500			7	Black	30170	4.50
		600~690			5	Black	30171	4.50
		120/208~144/250	3P+N+PE		9	Blue	30172	4.50
		200/346~240/415			6	Red	30173	4.50
					6	Red	30173	4.50
	125	200~250	3P+PE		9	Blue	30174	20.0
		380~415			6	Red	30175	20.0
		480~500			7	Black	30176	20.0
		600~690			5	Black	30177	20.0
		120/208~144/250	3P+N+PE		9	Blue	30178	20.0
		200/346~240/415			6	Red	30179	20.0



Technical data

Explosion-proof plug and sockets **BCZ85-16/□/□**

Explosion protection

Gas explosion protection

Dust explosion protection

⊕ II 2 G Ex d IIC T6 Gb

⊕ II 2 D Ex t IIIIC T80°C Db IP66

Certificates

Nemko 12 ATEX____; FM (USA); GOST.R (Russia); IECEX; CQST(China)

Conformity to standards

EN 60079-0:2009, EN 60079-1:2007, EN 60079-31:2009

IEC 60079-0:2007, IEC 60079-1:2007, IEC 60079-31:2008

Enclosure material

Copper-free aluminium; powder coated external surface

Enclosure colour

Window grey (RAL7040)

Exposed fastener

Stainless steel

Rated voltage

Max. 690V AC

Rated current

16A

Pole number

3P (2P+PE), 4P (3P+PE), 5P (3P+N+PE)

Degree of protection

IP66

Ambient temperature

-60°C ~ +55°C

Cable entry of socket

2 x M25 x 1.5(3P/4P), 2 x M32 x 1.5(5P)

Cable entry of plug

1 x M25 x 1.5(3P/4P), 1 x M32 x 1.5(5P)

Cable gland (optional)

DQM-II (Ex d) or DQM-III (Ex d) is recommended. Please see P7/20~25.

Dimension drawings (all dimensions in mm) - subject to alteration

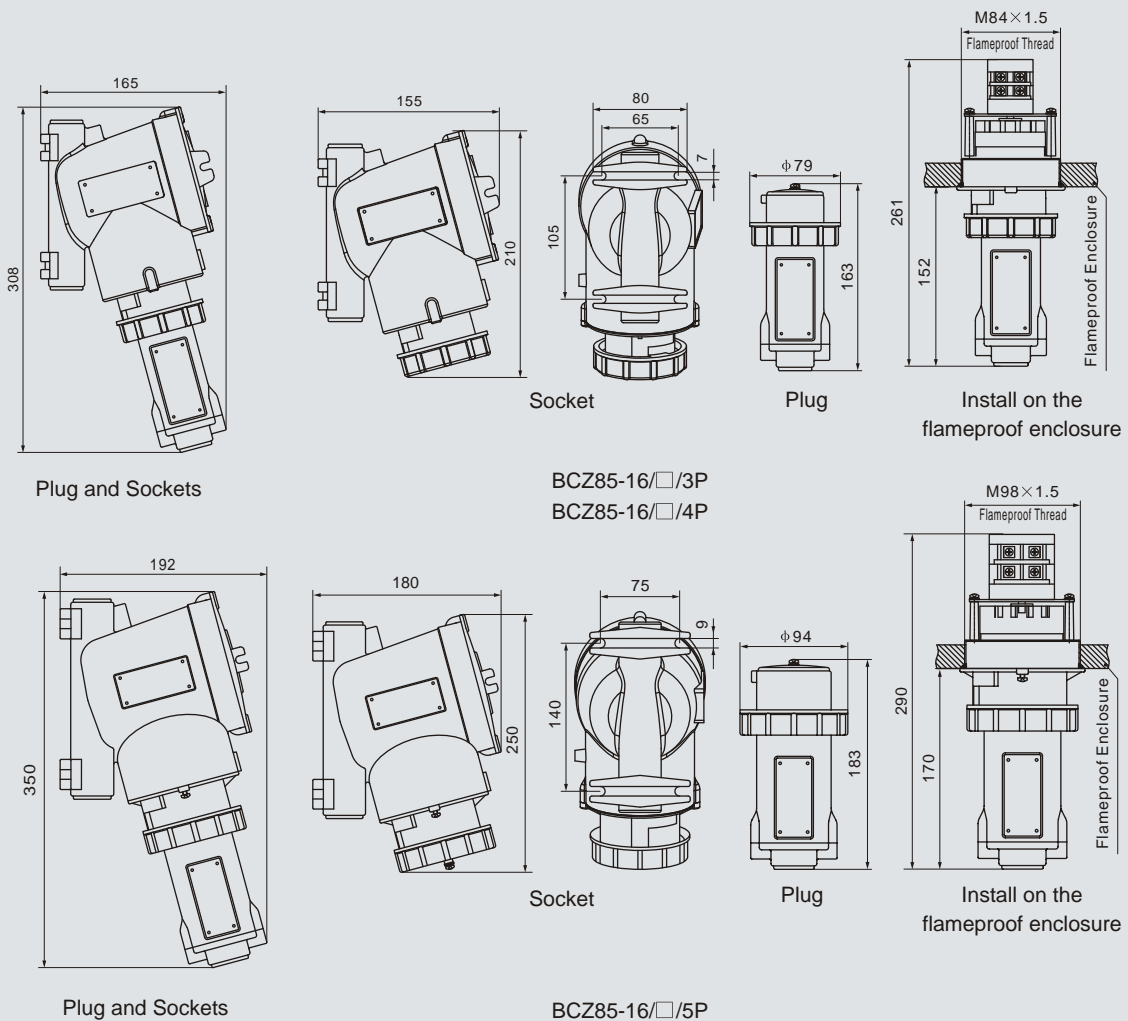

Technical data	
Explosion-proof plug and sockets BCZ85-32/□/□	
Explosion protection	<p>Gas explosion protection Ⓔ II 2 G Ex d IIC T6 Gb</p> <p>Dust explosion protection Ⓔ II 2 D Ex t IIIIC T80°C Db IP66</p>
Certificates	Nemko 12 ATEX____; FM (USA); GOST.R (Russia); IECEX; CQST(China)
Conformity to standards	EN 60079-0:2009, EN 60079-1:2007, EN 60079-31:2009 IEC 60079-0:2007, IEC 60079-1:2007, IEC 60079-31:2008
Enclosure material	Copper-free aluminium; powder coated external surface
Enclosure colour	Window grey (RAL7040)
Exposed fastener	Stainless steel
Rated voltage	Max. 690V AC
Rated current	32A
Pole number	3P (2P+PE), 4P (3P+PE), 5P (3P+N+PE)
Degree of protection	IP66
Ambient temperature	-60°C ~ +55°C
Cable entry of socket	2 x M32 x 1.5
Cable entry of plug	1 x M32 x 1.5
Cable gland (optional)	DQM-II (Ex d) or DQM-III (Ex d) is recommended. Please see P7/20~25.

Dimension drawings (all dimensions in mm) - subject to alteration

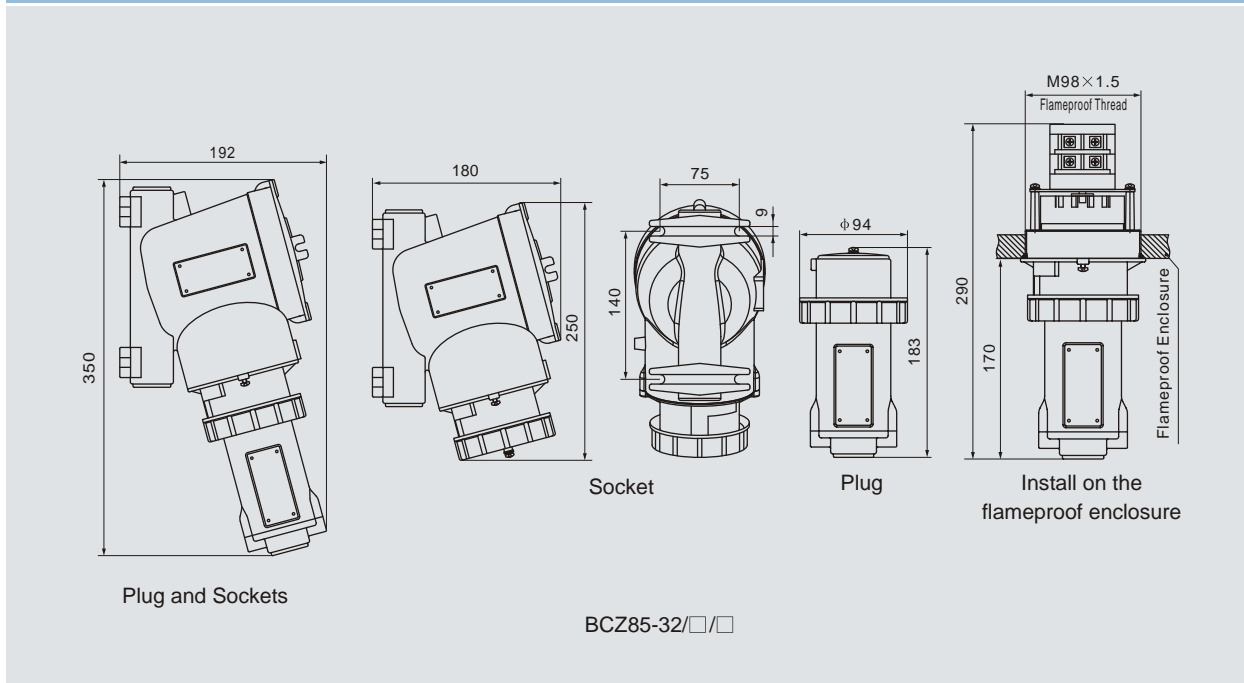

Technical data

Explosion-proof plug and sockets BCZ85-63/□/□

Explosion protection

Gas explosion protection

⊕ II 2 G Ex d IIC T6 Gb

Dust explosion protection

⊕ II 2 D Ex t IIIIC T80°C Db IP66

Certificates

Nemko 12 ATEX____; FM (USA); GOST.R (Russia); IECEX; CQST(China)

Conformity to standards

EN 60079-0:2009, EN 60079-1:2007, EN 60079-31:2009

IEC 60079-0:2007, IEC 60079-1:2007, IEC 60079-31:2008

Enclosure material

Copper-free aluminium; powder coated external surface

Enclosure colour

Window grey (RAL7040)

Exposed fastener

Stainless steel

Rated voltage

Max. 690V AC

Rated current

63A

Pole number

4P (3P+PE), 5P (3P+N+PE)

Degree of protection

IP66

Ambient temperature

-60°C~+55°C

Cable entry of socket

2 x M40 x 1.5

Cable entry of plug

1 x M40 x 1.5

Cable gland (optional)

DQM-II (Ex d) or DQM-III (Ex d) is recommended. Please see P7/20~25.

Dimension drawings (all dimensions in mm) - subject to alteration

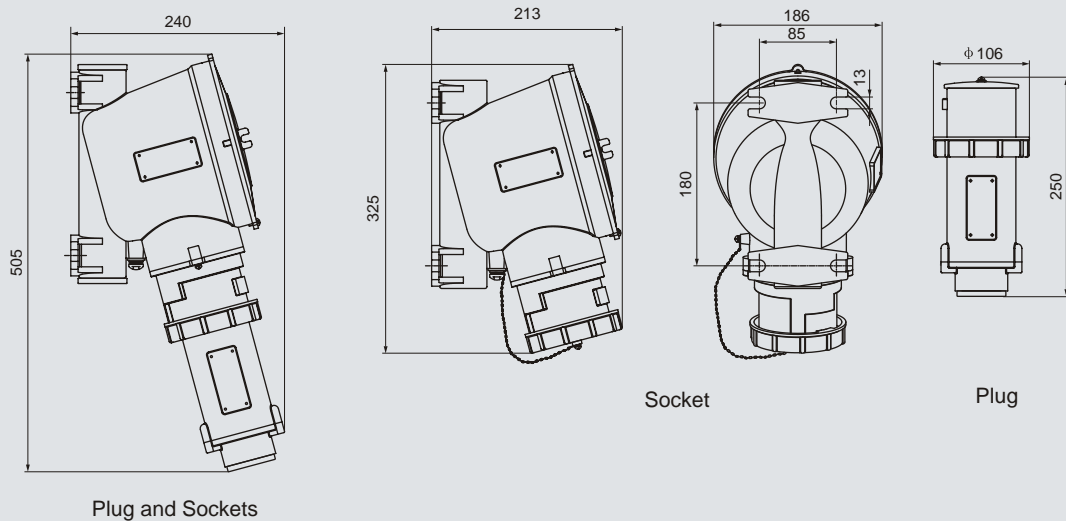

BCZ85-63/□/□

Technical data

Explosion-proof plug and sockets BCZ85-125/□/□

Explosion protection

Gas explosion protection
 Dust explosion protection

⊕ II 2 G Ex d IIC T6 Gb
 ⊕ II 2 D Ex t IIIC T80°C Db IP66

Certificates

Nemko 12 ATEX____; FM (USA); GOST.R (Russia); IECEX; CQST(China)

Conformity to standards

EN 60079-0:2009, EN 60079-1:2007, EN 60079-31:2009
 IEC 60079-0:2007, IEC 60079-1:2007, IEC 60079-31:2008

Enclosure material

Copper-free aluminium; powder coated external surface

Enclosure colour

Window grey (RAL7040)

Exposed fastener

Stainless steel

Rated voltage

Max. 690V AC

Rated current

125A

Pole number

4P (3P+PE), 5P (3P+N+PE)

Degree of protection

IP66

Ambient temperature

-60°C ~ +55°C

Cable entry of socket

1 x M63 x 1.5

Cable entry of plug

1 x M50 x 1.5

Cable gland (optional)

DQM-II (Ex d) or DQM-III (Ex d) is recommended. Please see P7/20~25.

Dimension drawings (all dimensions in mm) - subject to alteration

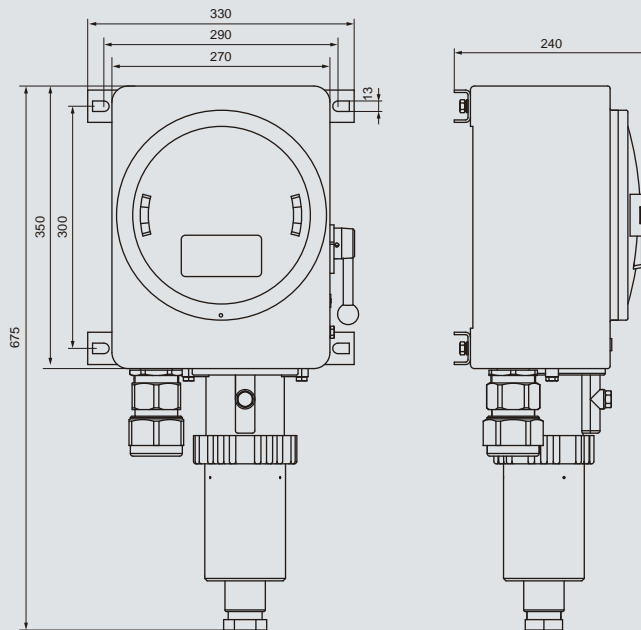

BCZ85-125/□/□

