



10342E00

STAHL

The plug and sockets Series SolConeX and CES comply with IEC/EN 60 309-1/-2 (CEE) and European standards EN 50 014, EN 50 018 and EN 50 019. The ability to plug the Ex-plug into non-Ex sockets is guaranteed, while operation of the Ex-socket using a non-Ex plug is reliably prevented.

Plugs and Sockets







SolConeX Series 8570, 8571

CES Series 8575, 8579, 8581

- Explosion protection to
 - CENELEC
 - IEC
 - NEC
- For use in
 - Zone 1 and Zone 2
 - Zone 21 and Zone 22
- Certified for
 - gas explosion protection
 - dust explosion protection
- Series
 - 8575: 16 A, extra low voltage
 - 8570: 16 A
 - 8571: 32 A
 - 8579: 63 A
 - 8581: 125 A
- Type of Protection IP 66
- Optimal contact by means of laminated contacts
- Individually encapsulated pins, flexibly embedded
- Switches
 - with large handle
 - can be locked in 0 and 1 positions
 - with clear switch position indication
 - with motor switching capacity AC3 acc. to IEC 60 947-3
 - with auxiliary contact for control and signalling purposes

Zones 1 & 2, 21 & 22

Selection Table

Version	Number of pins	Voltage [V]	Colour	Frequency [Hz]	h	Ordering Code	Weight kg
Small socket extra low voltage 16 A  01657E00	 2 P 06193E00	20 - 25	violet	50/60	--	8575/13-100	0,920
		20 - 25	violet	DC	10	8575/13-110	0,920
		40 - 50	light grey	50/60	12	8575/13-112	0,920
	 3 P 06199E00	20 - 25	violet	50/60	--	8575/13-200	0,940
		40 - 50	light grey	50/60	12	8575/13-212	0,940
Plug 16 A  10372E00	 2 P 09194E00	20 - 25	violet	50/60	--	8575/12-100	0,200
		20 - 25	violet	DC	10	8575/12-110	0,200
		40 - 50	light grey	50/60	12	8575/12-112	0,200
	 3 P 09193E00	20 - 25	violet	50/60	--	8575/12-200	0,220
		40 - 50	light grey	50/60	12	8575/12-212	0,220

Dimension drawings (all dimensions in mm) - subject to alterations

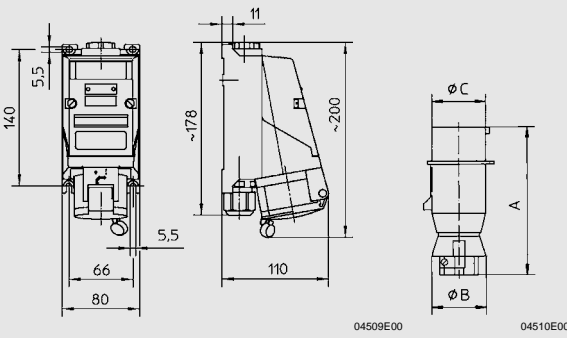









Type	A	B	C
8575/12-1.. (16 A, 2 P)	140	53,0	42,0
8575/12-2.. (16 A, 3 P)	140	53,0	42,0
8575/12-3.. (16 A, 2 P + ⊕)	159	58,5	43,5

8575/13-...
16 A Small socket

8575/12-...
16 A Plug



Selection Table





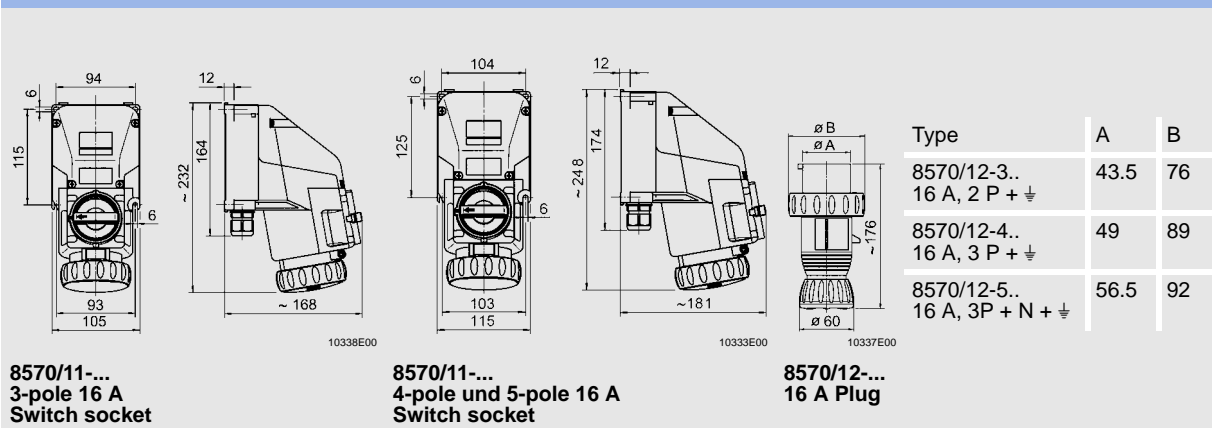

Version	Number of pins	Voltage [V]	Colour	Frequency [Hz]	h	Ordering Code	Weight kg
 10327E00	 06190E00 3 P (2 P + PE)	100 - 130	yellow	50/60	4	8570/11-304	1,120
		200 - 250	blue	50/60	6	8570/11-306	1,120
	 06556E00 4 P (3 P + PE)	200 - 250	blue	50/60	9	8570/11-409	1,350
		380 - 415	red	50/60	6	8570/11-406	1,350
		480 - 500	black	50/60	7	8570/11-407	1,350
		600 - 690	black	50/60	5	8570/11-405	1,350
	 06555E00 5 P (3 P + N + PE)	120/208 - 144/250	blue	50/60	9	8570/11-509	1,450
		200/346 - 240/415	red	50/60	6	8570/11-506	1,450
		277/480 - 288/500	black	50/60	7	8570/11-507	1,450
	 10329E00	 09195E00 3 P (2 P + PE)	100 - 130	yellow	50/60	4	8570/12-304
200 - 250			blue	50/60	6	8570/12-306	0,310
 09191E00 4 P (3 P + PE)		200 - 250	blue	50/60	9	8570/12-409	0,380
		380 - 415	red	50/60	6	8570/12-406	0,380
		480 - 500	black	50/60	7	8570/12-407	0,380
		600 - 690	black	50/60	5	8570/12-405	0,380
 09196E00 5 P (3 P + N + PE)		120/208 - 144/250	blue	50/60	9	8570/12-509	0,430
		200/346 - 240/415	red	50/60	6	8570/12-506	0,430
		277/480 - 288/500	black	50/60	7	8570/12-507	0,430
347/600 - 400/690		black	50/60	5	8570/12-505	0,430	

STAHL

Dimension drawings (all dimensions in mm) - subject to alterations



Selection Table

Version	Number of pins	Voltage [V]	Colour	Frequency [Hz]	h	Ordering Code	Weight kg
Switch socket 32 A  10324E00	 06556E00 4 P (3 P + PE)	200 - 250	blue	50/60	9	8571/11-409	2,000
		380 - 415	red	50/60	6	8571/11-406	2,000
		480 - 500	black	50/60	7	8571/11-407	2,000
	 06555E00 5 P (3 P + N + PE)	200/346 - 240/415	red	50/60	6	8571/11-506	2,200
		277/480 - 288/500	black	50/60	7	8571/11-507	2,200
Plug 32 A  10324E00	 09191E00 4 P (3 P + PE)	200 - 250	blue	50/60	9	8571/12-409	0,500
		380 - 415	red	50/60	6	8571/12-406	0,500
		480 - 500	black	50/60	7	8571/12-407	0,500
	 09196E00 5 P (3 P + N + PE)	600 - 690	black	50/60	5	8571/12-405	0,500
		200/346 - 240/415	red	50/60	6	8571/12-506	0,600
		277/480 - 288/500	black	50/60	7	8571/12-507	0,600



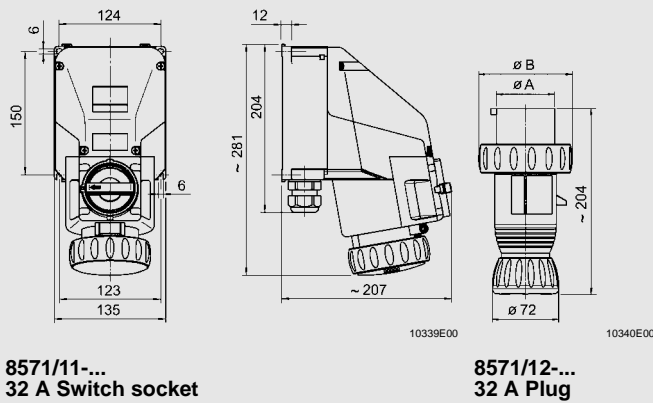



Dimension drawings (all dimensions in mm) - subject to alterations



Type	A	B
8571/12-4.. (32 A, 3 P + PE)	57	99
8571/12-5.. (32 A, 3 P + N + PE)	63.4	102



Selection Table

Version	Number of pins	Voltage [V]	Colour	Frequency [Hz]	h	Ordering Code	Weight kg
Switch socket 63 A  01679E00	 06556E00 4 P (3 P + PE)	200 - 250	blue	50/60	9	8579/11-409	7,600
		380 - 415	red	50/60	6	8579/11-406	7,600
		480 - 500	black	50/60	7	8579/11-407	7,600
	 06555E00 5 P (3 P + N + PE)	200/346 - 240/415	red	50/60	6	8579/11-506	7,800
		277/480 - 288/500	black	50/60	7	8579/11-507	7,800
Plug 63 A  01675E00	 09191E00 4 P (3 P + PE)	200 - 250	blue	50/60	9	8579/12-409	0,880
		380 - 415	red	50/60	6	8579/12-406	0,880
		480 - 500	black	50/60	7	8579/12-407	0,880
	 09196E00 5 P (3 P + N + PE)	200/346 - 240/415	red	50/60	6	8579/12-506	0,940
		277/480 - 288/500	black	50/60	7	8579/12-507	0,940

Dimension drawings (all dimensions in mm) - subject to alterations

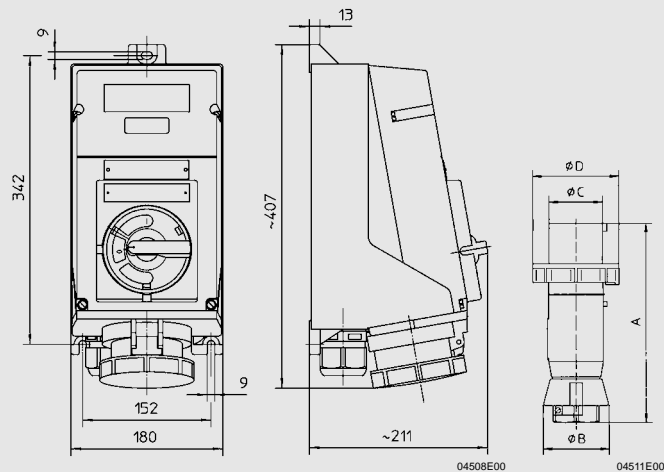







Type	A	B	C	D
8579/12-4.. (63 A, 3 P + PE)	268,5	84,0	69,5	112
8579/12-5.. (63 A, 3 P + N + PE)	268,5	84,0	69,5	112

**8579/11-...
63 A Switch socket**

**8579/12-...
63 A Plug**

Selection Table

Version	Number of pins	Voltage [V]	Colour	Frequency [Hz]	h	Ordering Code	Weight kg
Switch socket 125 A  01678E00	 06556E00 4 P (3 P + 1)	200 - 250	blue	50/60	9	8581/11-409	20,800
		380 - 415	red	50/60	6	8581/11-406	20,800
		480 - 500	black	50/60	7	8581/11-407	20,800
	 06555E00 5 P (3 P + N + 1)	200/346 - 240/415	red	50/60	6	8581/11-506	21,400
		277/480 - 288/500	black	50/60	7	8581/11-507	21,400
Plug 125 A  02231E00	 09191E00 4 P (3 P + 1)	200 - 250	blue	50/60	9	8581/12-409	1,280
		380 - 415	red	50/60	6	8581/12-406	1,280
		480 - 500	black	50/60	7	8581/12-407	1,280
	 09196E00 5 P (3 P + N + 1)	200/346 - 240/415	red	50/60	6	8581/12-506	1,380
		277/480 - 288/500	black	50/60	7	8581/12-507	1,380

Dimension drawings (all dimensions in mm) - subject to alterations

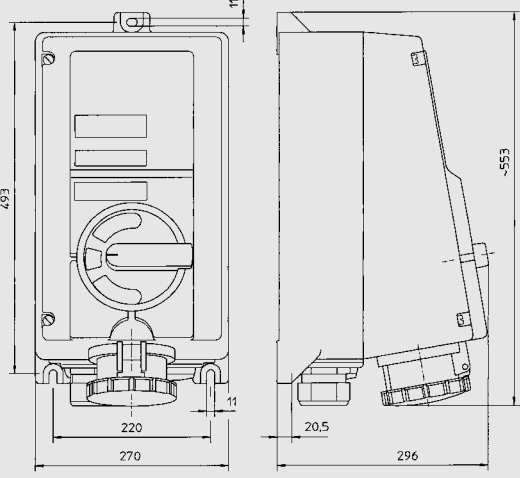

04118E00

**8581/11-...
125 A Switch socket**

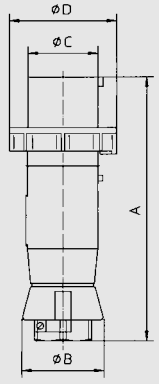

04512E00

**8581/12-...
125 A Plug**

	8581/12-4... 125 A 3 P + 1	8581/12-5... 125 A 3 P + N + 1
A	310.5	310.5
B	96.0	96.0
C	82.0	82.0
D	125	125



Technical Data		
Socket	8570/11 (16 A)	8571/11 (32 A)
Explosion protection		
Gas explosion protection	⊕ II 2 G EEx ed IIC T6	⊕ II 2 G EEx ed IIC T6
Dust explosion protection	⊕ II 2 D IP 66 T80°C	⊕ II 2 D IP 66 T80°C
Certificates		
Gas explosion protection	PTB 03 ATEX 1227	PTB 04 ATEX 1060
Dust explosion protection	PTB 03 ATEX 1227	PTB 04 ATEX 1060
Other certificates	IECEX Germanischer Lloyd	IECEX Germanischer Lloyd
Rated voltage		
Main contacts	max. 690 V AC max. 110 V DC	max. 690 V AC max. 110 V DC
Auxiliary contacts	max. 500 V AC / 110 V DC	max. 500 V AC / 110 V DC
Rated current		
Main contacts	16 A	32 A
Auxiliary contacts	max. 6 A	max. 6 A
Switching capacity	Main contacts: AC 3 690 V 16 A 4 kW 220 V / 230 V / 240 V 7.5 kW 380 V / 400 V / 415 V / 500 V 11 kW 600 V / 690 V DC1 110 V 16 A Auxiliary contacts: AC 15 500 V max. 1250 VA AC 15 230 V max. 1380 VA AC 12 500 V max. 3000 VA DC 13 110 V 110 W	Main contacts: AC 3 690 V 32 A 7.5 kW 220 V / 230 V / 240 V 15 kW 380 V / 400 V / 415 V 30 kW 600 V / 690 V Auxiliary contacts: AC 15 500 V max. 1250 VA AC 15 230 V max. 1380 VA AC 12 500 V max. 3000 VA DC 13 110 V 110 W
Back-up fuse		
without therm. protection	16 A gL	35 A gL
with therm. protection	35 A gL	63 A gL
Ambient temperature	- 20 °C ... + 40 °C - 50 °C ... + 55 °C on request	- 20 °C ... + 40 °C - 50 °C ... + 55 °C on request
Interlocked switch	max.4 pole switch 2 auxiliary contacts (ON - delayed, OFF - advanced)	max.4 pole switch 2 auxiliary contacts (ON - delayed, OFF - advanced)
Handle	Actuator is lockable in 0 and I position	Actuator is lockable in 0 and I position
Enclosure material	Polyamide GF30	Polyamide GF30
Degree of protection	IP 66	IP 66
Terminals	2 x 1.5 mm ² ... 6 mm ² solid 2 x 1.5 mm ² ... 4 mm ² flexible	2 x 2.5 mm ² ... 10 mm ² solid 2 x 2.5 mm ² ... 6 mm ² flexible
Cable entries		
Cable gland	1 x M 25 x 1.5 Cable entries are possible on the top or on the side wall (upon request)	1 x M 32 x 1.5 Cable entries are possible on the top or on the side wall (upon request)
Stopping plug	1 x M 25 x 1.5	1 x M 32 x 1.5
Plug	8570/12	8571/12
Further technical data	see sockets	see sockets
Enclosure material	Polyamide GF30	Polyamide GF30
Degree of protection	IP 66	IP 66
Terminals	1 x 1.5 mm ² ... 4 mm ² flexible	1 x 2.5 mm ² ... 10 mm ² flexible
Cable entries	8 mm ... 20 mm outer diameter	12 mm ... 28 mm outer diameter

Technical Data			
Socket	8575/13 (16 A Extra Low Voltage)	8579/11 (63 A)	8581/11 (125 A)
Explosion protection			
Gas explosion protection	⊕ II 2 G EEx ed IIC T6 or T5	⊕ II 2 G EEx ed [ib] IIC T5	⊕ II 2 G EEx ed [ib] IIC T6 or T5
Dust explosion protection	⊕ II 3 D IP 54 T80 °C, T95 °C	⊕ II 2 D IP 66 T95 °C, T130 °C	⊕ II 2 D IP 66 T80 °C, T95 °C
Certificates			
Gas explosion protection	PTB 01 ATEX 1044	PTB 01 ATEX 1150	PTB 01 ATEX 1161
Dust explosion protection	--	PTB 01 ATEX 1150	PTB 01 ATEX 1161
Other certificates	CSA (Canada), FM (USA), CTB (Russia)	IECEX, CSA (Canada), FM (USA), UL do Brasil (Brazil)	IECEX, UL do Brasil (Brazil)
Rated voltage			
Main contacts	max. 50 V	max. 690 V	max. 690 V
Auxiliary contacts	--	max. 400 V AC	max. 400 V AC
Rated current			
Main contacts	16 A	63 A	125 A
Auxiliary contacts	--	max. 6 A	max. 6 A
Switching capacity	AC 3: 50 V 16 A	AC 3: 690 V 63 A 18,5 kW: 220 V 230 V 240 V 30 kW: 380 V 400 V 415 V 37 kW: 500 V 55 kW: 690 V	AC 3: 500 V 125 A AC 23: 690 V 125 A
Back-up fuse			
without therm. protection	16 A gL/gG	63 A gL/gG	125 A gL/gG
with therm. protection	35 A gL/gG	80 A gL/gG	160 A gL/gG
Ambient temperature	- 20 °C ... + 40 °C	- 20 °C ... + 40 °C	- 20 °C ... + 40 °C
Interlocked switch	3 pole, switch with definite contacts (NC)	3 pole switch with isolating characteristics 1 auxiliary contact (ON - delayed, OFF - advanced)	3 pole switch with isolating characteristics 1 auxiliary contact (ON - delayed, OFF - advanced)
Handle	--	Actuator is lockable in 0 and I position	Actuator is lockable in 0 and I position
Enclosure material	Polyester resin	Polyester resin	Polyester resin
Degree of protection	IP 54	IP 66	IP 66
Terminals	2 x 4 mm ² , Additional slide-in terminal block with 2 supporting terminals for each 2 x 4 mm ²	1 x 35 mm ² with cable lug 2 x 35 mm ²	1 x 120 mm ² with additional clamping saddle 2 x 120 mm ²
Cable entries			
Cable gland	1 x M 25 x 1.5 Cable entries are possible on the top or on the side wall (upon request)	1 x M 50 x 1.5 Cable entries are possible on the top or on the side wall (upon request)	1 x M 63 x 1.5 Cable entries are possible on the top or on the side wall (upon request)
Stopping plug	1 x M 25 x 1.5	1 x M 25 x 1.5	1 x M 25 x 1.5; 1 x M 63 x 1.5
Plug	8575/12	8579/12	8581/12
Further technical data	see sockets	see sockets	see sockets
Enclosure material	Polyamide	Polyamide	Polyamide
Degree of protection	IP 54	IP 66	IP 66
Terminals	4 mm ²	16 mm ²	35 mm ²
Cable entries	11 mm ... 21 mm outer diameter	24 mm ... 36 mm outer diameter	30 mm ... 50 mm outer diameter



Arrangement of contact bushes

Example:
Position clockwise,
Front view of socket

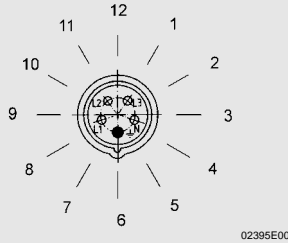



Example:
Position clockwise

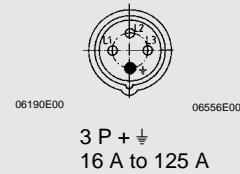

Marking of contacts
Front view of socket

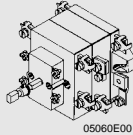
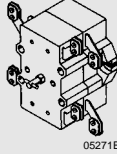

Accessories and Spare Parts

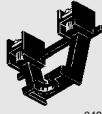
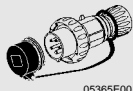
Designation	Illustration	Description	Ordering code	Weight kg
Switch	 05060E00	for socket: 8579/11	8543016020	1,529
	 05271E00	for socket: 8581/11	8548017020	4,101
Auxiliary contact (retrofitable)	 10341E00	1 NO	8570802760	0,125
		1 NC	8570801760	0,125
		1 NO, gold contact	8570804760	0,125
		1 NC, gold contact	8570803760	0,125
Additional terminal block	 04911E00		8575011660	0,019
Protection cap	 05365E00	for plug 16 A 3 poles not for extra low voltage version	8570001140	0,043
		for plug 16 A 4 poles	8570002140	0,049
		for plug 16 A 5 poles	8570003140	0,056
		for plug 32 A 4 poles	8571001140	0,070
		for plug 32 A 5 poles	8571002140	0,077
		for plug 63 A 4/5 poles	8579801140	0,100
		for plug 125 A 4/5 poles	8581801140	0,120

We reserve the right to make alterations to the technical data, weights, dimensions, designs and products available without notice. The illustrations cannot be considered binding.